

**FRONT VIEW**

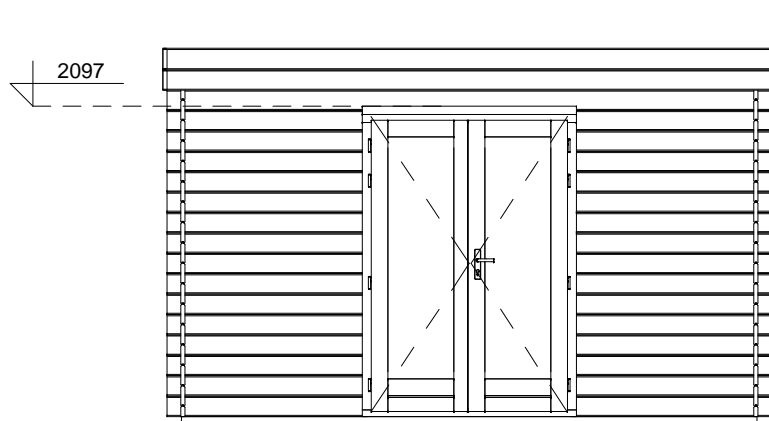

**LEFT SIDE VIEW**

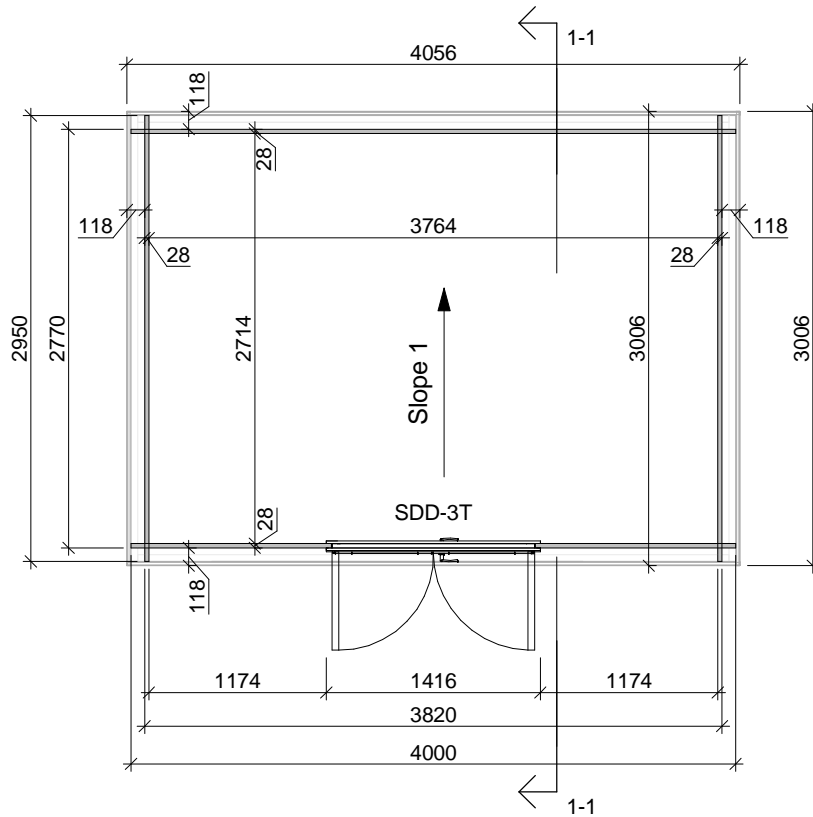
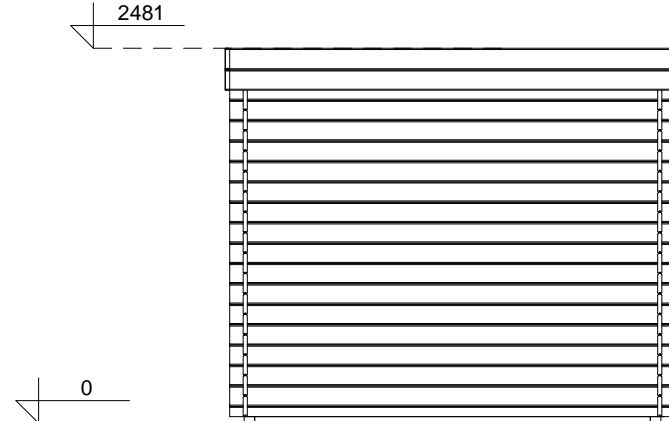

**FLOOR PLAN**

**SECTION 1-1**

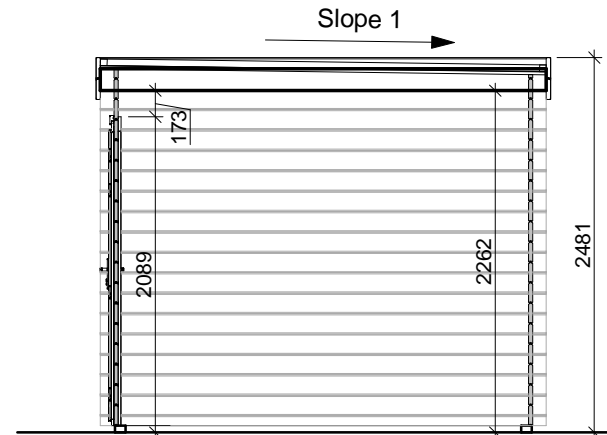

Project Nr.

**BS\_03 Log cabin 400x295cm 28mm**

ARCHITECTURE DRAWINGS	Scale	Drawer	Sheet Nr.	Date
	1 : 50	DB	AR - 1	13.05.2022 16:37:20

**REAR VIEW**

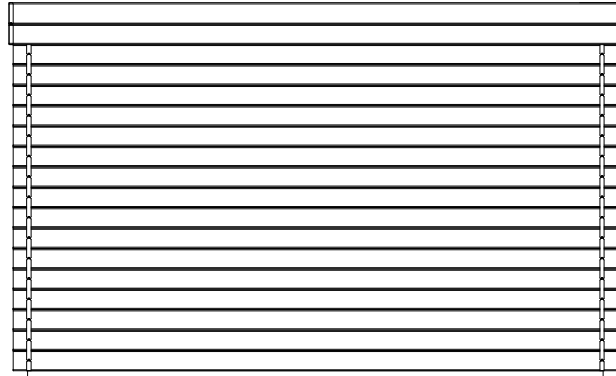

**RIGHT SIDE VIEW**

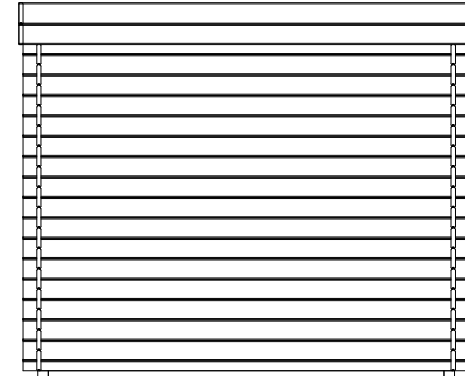

2481

0

**3D VIEW**

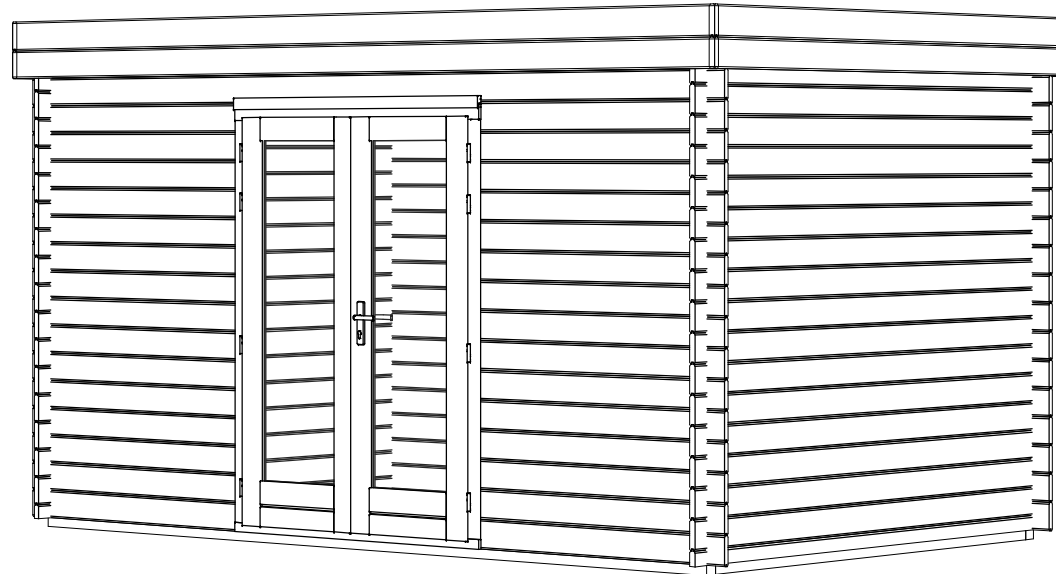

Project Nr.

**BS\_03 Log cabin 400x295cm 28mm**

ARCHITECTURE  
DRAWINGS

Scale

1 : 50

Drawer

DB

Sheet Nr.

AR - 2

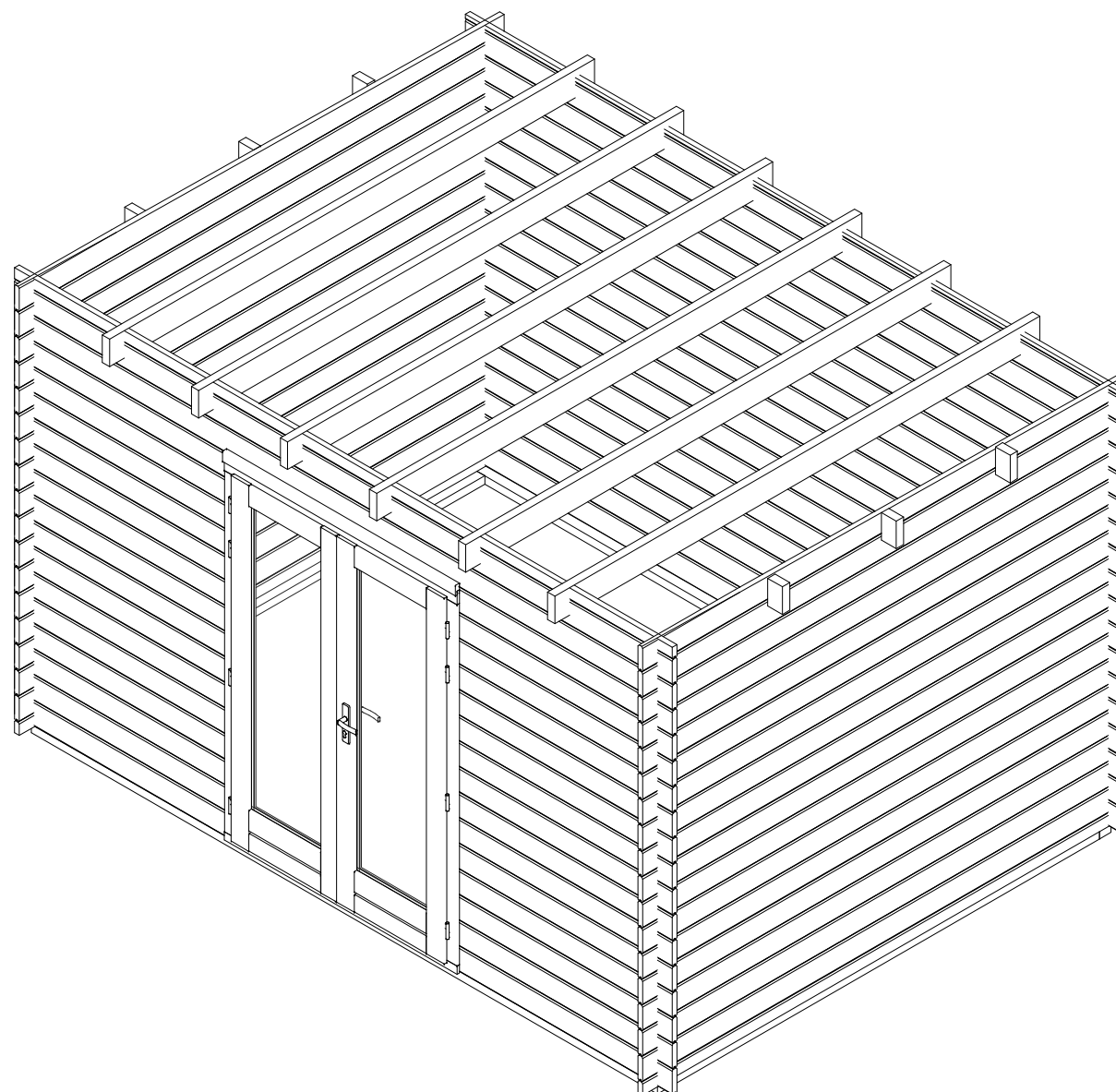

Date

13.05.2022  
16:37:21

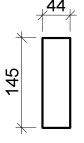

Project Nr.				
<b><i>BS_03 Log cabin 400x295cm 28mm</i></b>				
ARCHITECTURE DRAWINGS	Scale	Drawer	Sheet Nr.	Date
		DB	AR - 3	13.05.2022 16:37:21

### ROOF PART SPECIFICATION

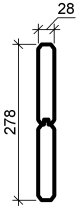
Type Image	Keynote	Description
	RB 18x88	Roof board 18mm
	RJ 44x145	Roof joist 44x145
	RS 44x44	Roof side board 44x44
	WB 28	Wind board 28mm

### FLOOR PART SPECIFICATION

Type Image	Keynote	Description
	BB 44x70	Base beam 44x70

### DOOR SCHEDULE

Keynote	Count
SDD-3T	1
	1

### WINDOW SCHEDULE

Keynote	Count
---------	-------

### ROOF SCHEDULE

Roof type	Area
Flat	12 m <sup>2</sup>
	12 m <sup>2</sup>

### FLOOR SCHEDULE

Description	Area
-------------	------

Project Nr.

**BS\_03 Log cabin 400x295cm 28mm**

ARCHITECTURE  
DRAWINGS

Scale

Drawer

Sheet Nr.

Date

DB

AR - 4

13.05.2022  
16:37:21