

FRONT VIEW

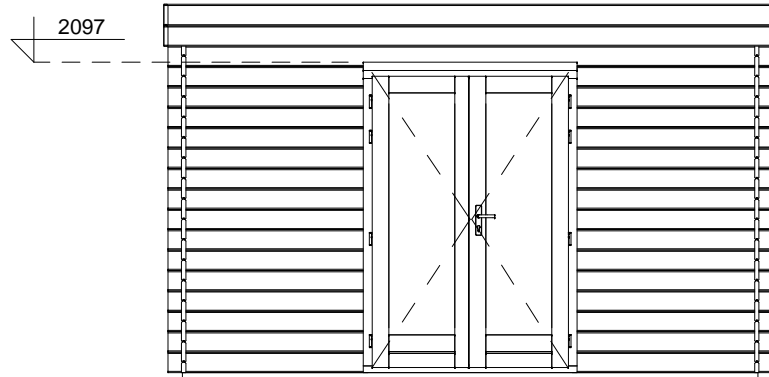

LEFT SIDE VIEW

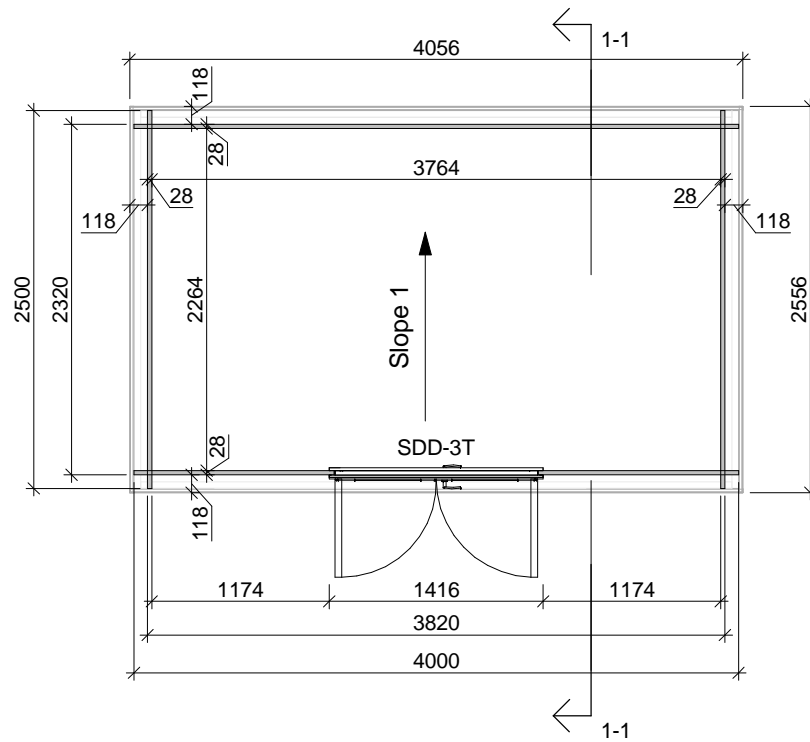
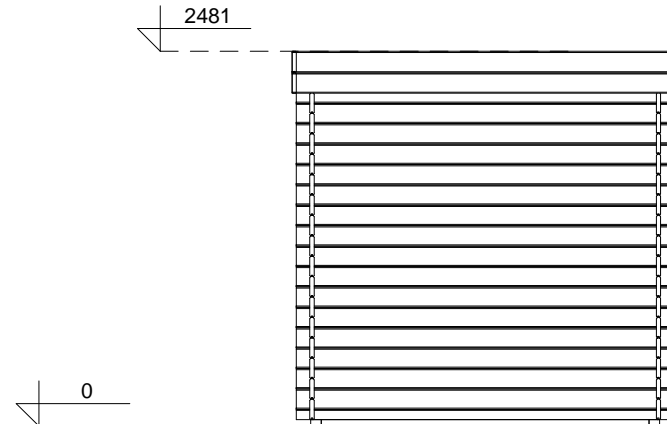

FLOOR PLAN

SECTION 1-1

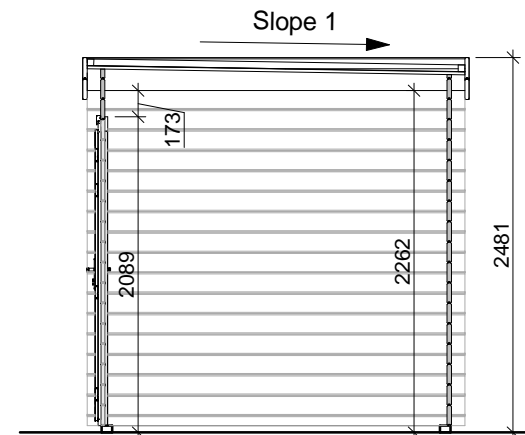

Project Nr.

BS_07 Log cabin 400x250cm 28mm

ARCHITECTURE DRAWINGS	Scale	Drawer	Sheet Nr.	Date
	1 : 50	DB	AR - 1	13.05.2022 16:32:02

REAR VIEW

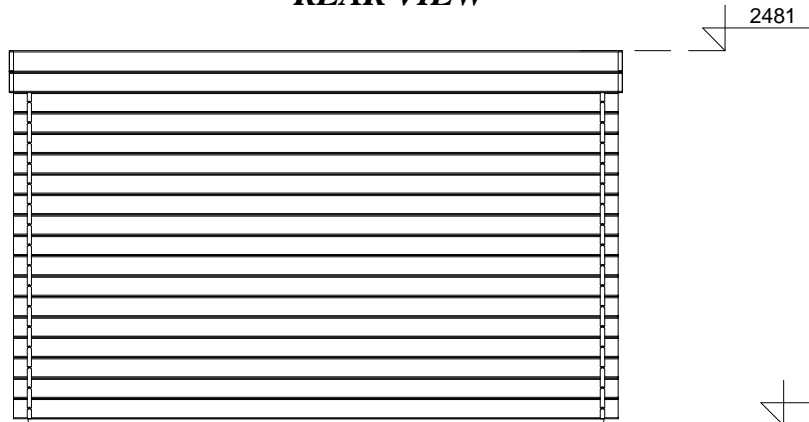

RIGHT SIDE VIEW

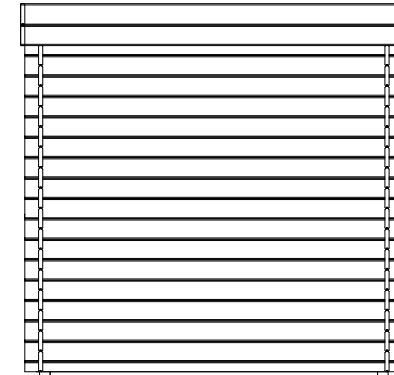

3D VIEW

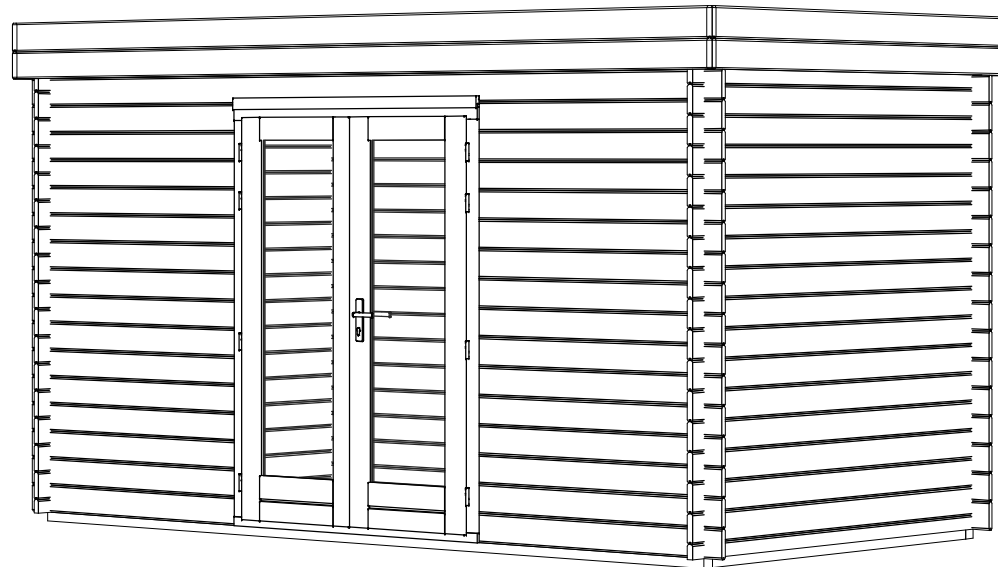

Project Nr.

BS_07 Log cabin 400x250cm 28mm

ARCHITECTURE
DRAWINGS

Scale

1 : 50

Drawer

DB

Sheet Nr.

AR - 2

Date

13.05.2022
16:32:02

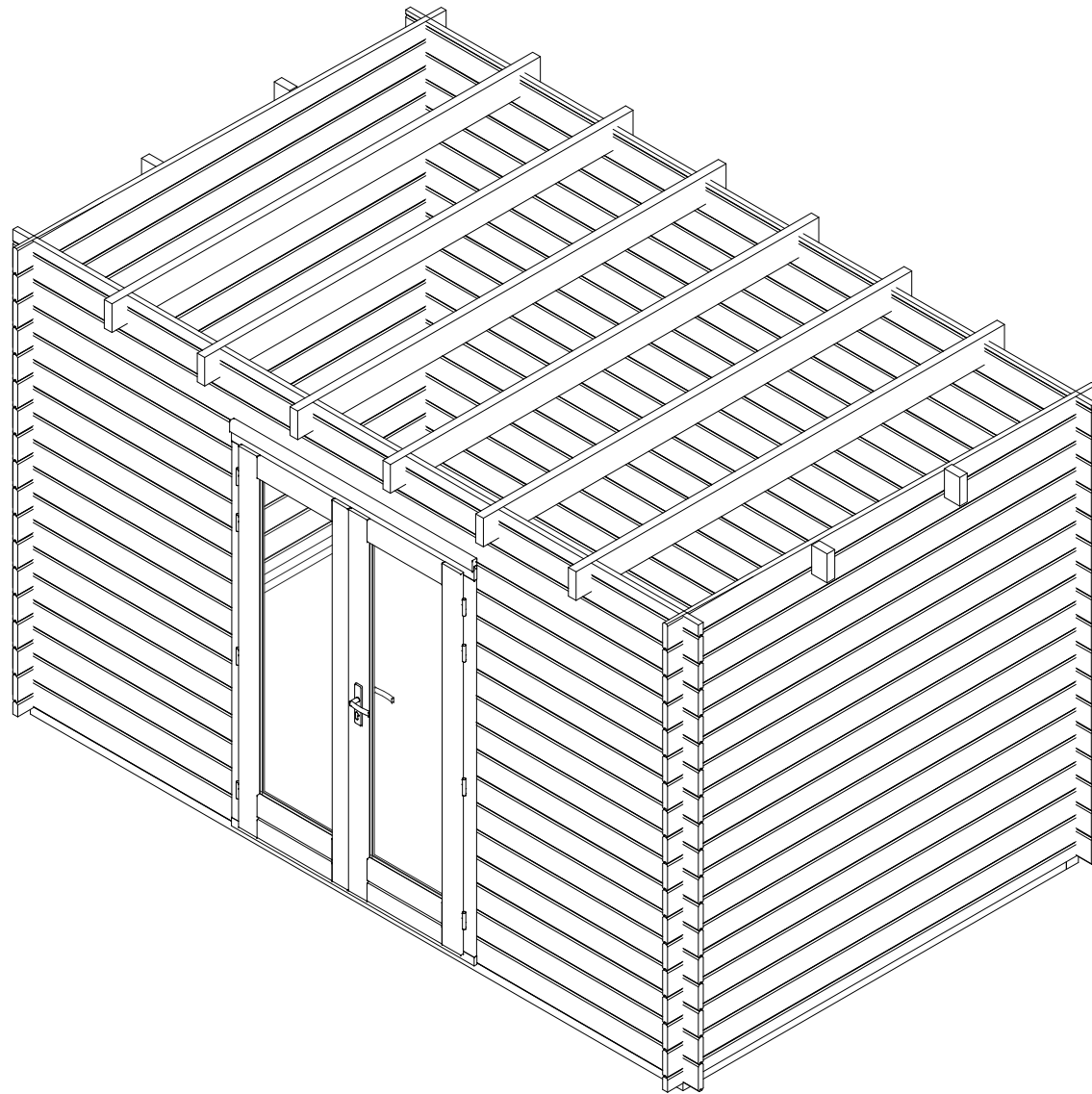



Project Nr.

BS_07 Log cabin 400x250cm 28mm

ARCHITECTURE DRAWINGS	Scale	Drawer	Sheet Nr.	Date
			DB	AR - 3

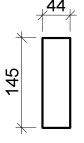
ROOF PART SPECIFICATION

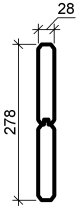
Type Image	Keynote	Description
	RB 18x88	Roof board 18mm
	RJ 44x145	Roof joist 44x145
	RS 44x44	Roof side board 44x44
	WB 28	Wind board 28mm

FLOOR PART SPECIFICATION

Type Image	Keynote	Description
	BB 44x70	Base beam 44x70

DOOR SCHEDULE

Keynote	Count
SDD-3T	1
	1

WINDOW SCHEDULE

Keynote	Count
---------	-------

ROOF SCHEDULE

Roof type	Area
Flat	10 m ²
	10 m ²

FLOOR SCHEDULE

Description	Area
-------------	------

Project Nr.

BS_07 Log cabin 400x250cm 28mm

ARCHITECTURE
DRAWINGS

Scale

Drawer

Sheet Nr.

Date

DB

AR - 4

13.05.2022
16:32:02